

Technician Guidelines for Antilock Braking Systems

Air-Braked Trucks, Tractors and Trailers

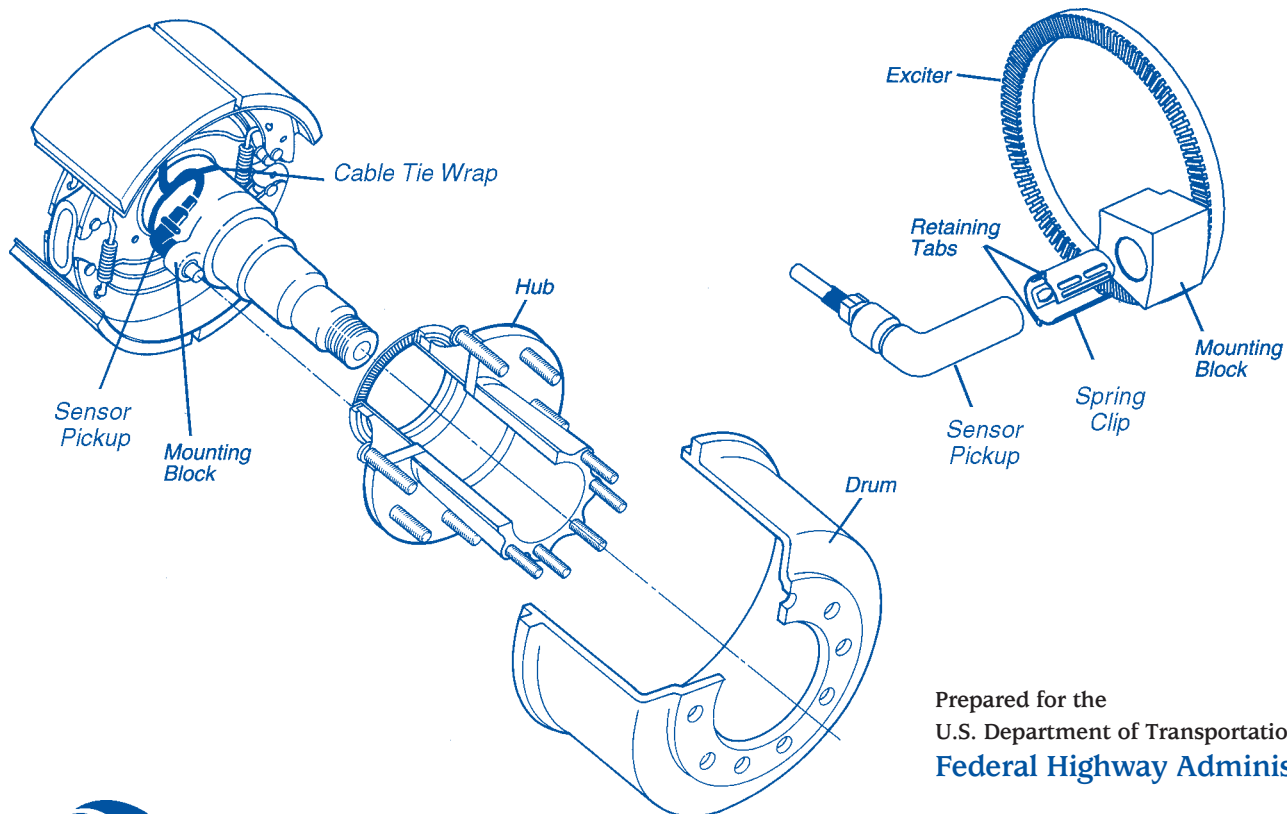

Prepared for the
U.S. Department of Transportation
Federal Highway Administration

by

The Maintenance Council

American Trucking Associations
2200 Mill Road
Alexandria, Virginia 22314



Federal Highway Administration
U.S. Department of Transportation



Technician Guidelines For Antilock Braking Systems

Air-Braked Trucks, Tractors, and Trailers



FHWA-MC-98-008

**Prepared for the
U.S. Department of Transportation
Federal Highway Administration**

400 Seventh Street , S.W.
Washington, D.C. 20590

by

The Maintenance Council

American Trucking Associations
2200 Mill Road
Alexandria, Virginia 22314
(703) 838-1763

Technical Report Documentation Page

1. Report No. FHWA-MC-98-008	2. Government Accession No.	3. Recipient's Catalog No.	
4. Title and Subtitle Technician Guidelines for Antilock Braking Systems		5. Report Date March 1, 1998	
7. Author(s) The Maintenance Council of the American Trucking Associations		6. Performing Organization Code	
9. Performing Organization Name and Address The Maintenance Council of the American Trucking Associations 2200 Mill Road Alexandria, VA 22314		8. Performing Organization Report No.	
12. Sponsoring Agency Name and Address Federal Highway Administration Office of Motor Carrier Research and Standards 400 Seventh St., S.W. Washington, DC, 20590		10. Work Unit No.	
15. Supplementary Notes L. Minor — Contracting Officer's Technical Representative (COTR)		11. Contract or Grant No. DTFH61-93-C-00088	
16. Abstract This manual provides generic technician guidelines for inspecting, maintaining and troubleshooting antilock braking systems (ABSs) used on air-braked, heavy vehicles.		13. Type of Report & Period Covered	
17. Key Words ABS, air brakes, antilock braking systems, stopping capability, stability and control, brake inspection.		18. Distribution Statement No restrictions. Available through the National Technical Information Service, Springfield, VA 22161. Telephone: (703) 605-6000	
19. Security Classification (of report) None	20. Security Classification (of this page) None	21. No. of pages 44	22. Price

PURPOSE

The purpose of this document is to provide truck technicians with general guidelines for ABS operation, maintenance, inspection and troubleshooting. Technicians should always consult the appropriate vehicle or component manufacturer's information for specific ABS procedures.

DISCLAIMER

This document is disseminated under the sponsorship of the Department of Transportation in the interest of information exchange. The United States Government assumes no liability for its contents or use thereof. The contents of this document do not necessarily reflect the official policy of the Department of Transportation. This publication does not constitute a standard, specification or regulation.

The Maintenance Council and the Trucking Research Institute have made a reasonable effort to ensure the accuracy of information contained in this publication. However, all equipment users should satisfy themselves that the procedures outlined herein are appropriate for their own use.

The United States Government does not endorse products or manufacturers. Trade or manufacturers' names appear herein only because they are considered essential to the object of this document.

ACKNOWLEDGMENT

The authors extend their thanks to the following organizations which contributed to the development of this document.

- American Trucking Associations' Engineering Dept.
- The ATA Foundation
- Bendix/AlliedSignal Corporation
- Eaton-Bosch
- Federal Highway Administration
- Midland-Grau
- Rockwell WABCO
- The Maintenance Council's ABS/EBS Task Force and S.6 Chassis Study Group.

TABLE OF CONTENTS

- I. AN INTRODUCTION TO ANTILOCK BRAKING 3
 - A. What is an ABS? 3
 - B. How Do ABSs Work? 5
 - C. How Should I Drive an ABS-equipped Vehicle
During Road Tests? 6
 - D. What Are the Features and Benefits of ABSs? 7
- II. ABS COMPONENT DESCRIPTIONS AND
OPERATION 8
 - A. Electronic Control Unit (ECU) 8
 - B. Modulator Valves 10
 - C. Wheel Speed Sensors 11
 - D. ABS Malfunction Indicator Lamps 12
 - E. ABS Diagnostics 12
 - F. Traction Control Systems 13
- III. ABS TROUBLESHOOTING, MAINTENANCE AND
INSPECTION 14
 - A. ABS Troubleshooting 14
 - 1. General Diagnostic Principles 14
 - 2. Notes on Electrical/Electronic Connections .. 19
 - 3. Error Detection Methods 23
 - 4. Causes of Common ABS Sensor Problems 25
 - B. ABS Maintenance and Inspection 27
 - 1. ABS Sensor Pickup Adjustment 27
 - 2. ABS Sensor Pickup Removal and Installation 27
 - 3. Sensor Pickup Removal—Front Axle 27
 - 4. Sensor Pickup Installation—Front Axle 27
 - 5. Sensor Pickup Removal—Rear Axle 28
 - 6. Sensor Pickup Installation—Rear Axle 28
 - 7. Proper ABS Sensor Resistance 29
 - 8. Modulator Valves/Routine Inspection 29
 - 9. Modulator Valve Removal and Installation .. 30
 - 10. Proper ABS Modulator Valve Resistance 30
- IV. ABS SPEC'ING CONSIDERATIONS 31
- V. GLOSSARY OF ABS TERMS 33
- VI. INDEX 42



I. AN INTRODUCTION TO ANTILOCK BRAKING

This section reviews several basic antilock braking system (ABS) concepts. When you complete this section, you should be able to answer the following questions:

- What is an ABS?
- Why are antilock braking systems (ABSs) standard on most new commercial vehicles?
- How does an ABS work?
- What are the major features and benefits of ABSs?
- How should I drive an ABS-equipped vehicle during a road test?

A. What is an ABS?

Antilock braking systems (ABSs) are electronic systems that monitor and control wheel slip during vehicle braking.

Antilock braking systems (ABSs) are electronic systems that monitor and control wheel slip during vehicle braking. ABSs can improve vehicle control during braking, and reduce stopping distances on slippery (split or low coefficient of friction) road surfaces by limiting wheel slip and minimizing lockup. Rolling wheels have much more traction than locked wheels. Reducing wheel slip improves vehicle stability and control during braking, since stability increases as wheel slip decreases.

ABSs can be applied to nearly all types of vehicles and can be successfully integrated into hydraulic and air brake systems (including air over hydraulic). This document applies to the ABSs used with air brake systems on commercial vehicles.

The National Highway Traffic Safety Administration (NHTSA) requires—through FMVSS 121, “Air Brake Systems” and FMVSS 105, “Hydraulic Brake Systems”—that ABSs be installed on commercial vehicles built (built meaning the official date of manufacture) on or after:

- March 1, 1997, for air-braked truck-tractors.
- March 1, 1998, for other air-braked vehicles (trucks, buses, trailers and converter dollies).
- March 1, 1999, for hydraulically braked trucks and buses with gross vehicle weight ratings of more than 10,000 lbs.

Reducing wheel slip improves vehicle stability and control during braking, since stability increases as wheel slip decreases.

The equipment requirements of FMVSS 121 specify that ABSs on truck-tractors and full trailers must control the brake

pressures to at least one front axle and one rear axle. The ABSs on semi-trailers and dollies must control at least one axle of the vehicle. Additionally, the ABSs on tractors must control one of the rear axles with two modulator valves so that the brake pressure on one end of the axle is independent of the brake pressure on the other end. The performance requirements of FMVSS 121 can require an ABS on additional axles.

NHTSA defines an ABS as a portion of a service brake system that automatically controls the degree of rotational wheel slip during braking by:

- Sensing the rate of angular wheel rotation.
- Transmitting signals regarding the rate of wheel rotation to one or more devices, which interpret these signals and generate responsive controlling output signals.
- Transmitting those signals to one or more devices which adjust braking forces in response to the signals.

Other aspects of NHTSA's rule stipulate that:

- ABSs on trailers be capable of being powered by the trailer's stop lamp circuit.
- New tractors—built on or after March 1, 1997—provide constant electrical power to a tractor-to-trailer electrical connector for powering trailer ABSs.
- Vehicles required to have an ABS also have a yellow ABS malfunction indicator lamp which lights up to indicate most malfunctions.
- The power unit's ABS malfunction lamp be “in front of and in clear view” of the driver. It lights when the ignition key is first switched “on” for a bulb check.
- The ABS malfunction lamp on trailers be mounted on the left side of the trailer, near the rear side marker lamp. On dollies, the lamp is located on the left side where it can be seen by someone standing about 10 feet from the lamp. The lamp lights for a short bulb check when the vehicle is stopped and the ABS starts receiving electrical power. This lamp will no longer be required after February 2009.
- Air-braked tractors and trucks which tow other air-braked vehicles—built on or after March 1, 2001—have an in-cab warning lamp which indicates

malfunctions in any towed trailer's or dolly's ABS. Its location and function are the same as for the powered unit's ABS malfunction lamp.

- Trailer and dolly ABSs—built on or after March 1, 2001—have the equipment needed to send an ABS malfunction signal to the towing vehicle. A towing trailer must also be able to relay an ABS malfunction signal from the vehicle it is towing to the vehicle towing it.

B. How Do ABSs Work?

Electronic controls allow an ABS to adjust brake pressure faster and more accurately than can drivers.

An ABS consists of several key components: electronic control unit (ECU), wheel speed sensors, modulator valves, and exciter rings. Here's how these components work together:

1. Wheel speed sensors constantly monitor and send electrical pulses to the ECU at a rate proportional to the wheel speed.
2. When the pulse rates indicate impending wheel lockup, the ECU signals the modulator valve(s) to reduce and/or hold the brake application pressure to the wheel(s) in question.
3. The ECU then adjusts pressure, seeking one which gives maximum braking without risking wheel lockup.
4. When the ECU acts to modulate the brake pressure, it will also (on most vehicles) turn off the retarder (if so equipped) until the risk of lockup is over.
5. The ECU continually checks itself for proper operation. If it detects a malfunction/failure in the electrical/electronic system, it will shut down that part of the ABS affected by the problem—or the entire ABS—depending upon the system and the problem. When this happens, the ABS malfunction lamp lights.

An ABS is more effective on slippery roads because it tailors the brake pressure at the wheel to maximize vehicle braking and stability.

An ABS adjusts brake pressure much faster and more accurately than can drivers. It's faster because:

- electronic controls are very fast and
- ABS modulator valves are physically closer to the brakes than is the driver's foot brake valve.

It is more effective, too, because an ABS can tailor the brake pressure to each wheel or set of wheels to provide maximum

braking/stability. Some vehicles also use a traction control system in conjunction with the ABS. Traction control helps the ABS improve vehicle traction by minimizing wheel slip on the drive axle during acceleration. If a wheel on the drive axle starts to slip, the traction control system automatically brakes the wheel slightly, transferring engine torque to the wheels with better traction. If all the drive wheels start to slip, the traction control system may also reduce engine power.

Traction control systems are referred to by several different names, depending on the manufacturer. These include:

- Automatic Traction Control (ATC)
- Traction Control (TC)
- Automatic Slip Regulation/Anti-Spin Regulation (ASR)

C. How Should I Drive an ABS-equipped Vehicle During Road Tests?

It is the consensus of brake experts that drivers should brake an ABS-equipped vehicle just as they would brake a non-ABS equipped vehicle.

The proper braking technique is to maintain a steady, modulated brake application. Modulated, in this case, means applying only the pressure required to achieve the desired deceleration. Do not slam on the brakes to make speed corrections or routine stops.

When operating on slippery surfaces, with or without an ABS, it is strongly recommended that drivers depress the clutch when braking. Engine braking itself can cause drive wheels to slip. Usually, any retarder will automatically be disabled when the ABS is in use.

Much of what is taught about hydraulic ABSs doesn't apply to air ABSs. Thus, it's important to remember the following:

- Brake as if no ABS is present, with a modulated application as described previously.
- Unless certain that the entire combination vehicle has a working ABS, don't stomp on the brakes in a panic situation—one or more wheels could lock and cause the vehicle to jackknife. Even then, be careful because you can still jackknife or lose control if the vehicle is travelling too fast.
- Do not expect to feel the brake pedal pulsing or hear strange sounds when the ABS activates on air-braked vehicles. These vehicles do not transmit pulsing pressure to the driver's foot and the driver probably will not hear the system cycling.

Brake an ABS-equipped vehicle just as you would brake a non-ABS equipped vehicle.

Only apply the pressure required to achieve the desired deceleration.

- Operate mixed combination vehicles (with and without an ABS) the same way one would operate totally non-ABS combination vehicles. Apply only the brake pressure needed to achieve the desired deceleration while ensuring vehicle stability. Monitor the combination vehicle behavior and back off the brake pedal, if possible, to keep the units under control.

D. What Are the Features and Benefits of ABSs?

Table 1 lists the major features and benefits offered by ABSs:

TABLE 1: ABS Features and Benefits	
FEATURE	BENEFIT
Control of steering, drive and trailer wheels	Increases steering ability and vehicle stability during braking Reduces possibility of jackknifing and trailer swing Reduces tire flatspotting
Fail-safe electrical/electronic system	If the electrical/electronic system fails, the ABS is shut off, returning the vehicle to normal braking. On some systems, the ABS is only shut off at the affected wheels.
Traction control	An optional feature that controls excessive wheel spin during acceleration, reducing the possibility of power skids, spins or jackknives.
Self-diagnosing system	Built-in system makes maintenance checks quick and easy.
Diagnostic tool compatibility	ABSs are compatible with industry standard hand-held and computer-based diagnostic tools. Blink codes and other diagnostic schemes can also be used for troubleshooting, if other tools are not available.
ABS Malfunction Indicator Lamp	Informs the driver or technician that an ABS fault has occurred. The warning lamp may also transmit blink code information. It does not signal all possible faults.

II. ABS COMPONENT DESCRIPTIONS & OPERATION

This section describes the design and operation of ABS components.

When you complete this section, you should understand the purpose and function of all major ABS parts including: the ECU, the modulator valve, the wheel speed sensor, ABS malfunction/indicator lamp, ABS diagnostic components, and traction control.

Modern antilock braking systems all feature the following major components (See **Fig. 1** on page 9 for typical system):

- Electronic Control Unit (ECU)
- Modulator Valves
- Wheel Speed Sensors (pickup and exciter)
- ABS Malfunction Indicator Lamps
- Diagnostics

A. Electronic Control Unit (ECU)

The ECU processes all ABS information and signal functions. It receives and interprets voltage pulses generated by the sensor pickup as the exciter teeth pass by, and uses this information to determine:

- impending wheel lock-up and
- when/how to activate the ABS modulator valves.

The ECU connects to the following ABS components: wheel speed sensors, ABS modulator valves, power source, ground, warning lamps, blink code switch, J1587* diagnostic connector, and retarder control device (usually by relay or the J1922**/J1939*** datalink.) The ECU also makes self-diagnostic checks during normal operation.

During braking, the ECU uses voltage pulses from each wheel speed sensor to determine wheel speed changes. If the ECU determines that the pulse rate of the sensed wheels indicates imminent lock-up, it cycles the ABS modulator valves to modify brake air pressure as needed to provide the best braking possible.

The ECU sends signals to the ABS malfunction indicator lamp or blink code lamp to communicate ABS faults. It also sends signals to the retarder control to disengage the retarder when the ABS is working. When the ABS stops modulating the brake pressure, the ECU permits retarder use once again.

*** SAE J1587, Joint SAE/TMC Recommended Practice for Electronic Data Interchange Between Microcomputer Systems in Heavy-duty Vehicle Applications. (See Glossary of ABS Terms for definition of SAE.)**

****SAE J1922, Powertrain Control Interface for Electronic Controls Used in Medium- and Heavy-duty Diesel On-highway Applications.**

*****SAE J1939, A series of SAE Recommended Practices that define architecture and protocol for a serial control and communications network for various equipment types.**

FIGURE 1: TYPICAL TRACTOR ABS SCHEMATIC

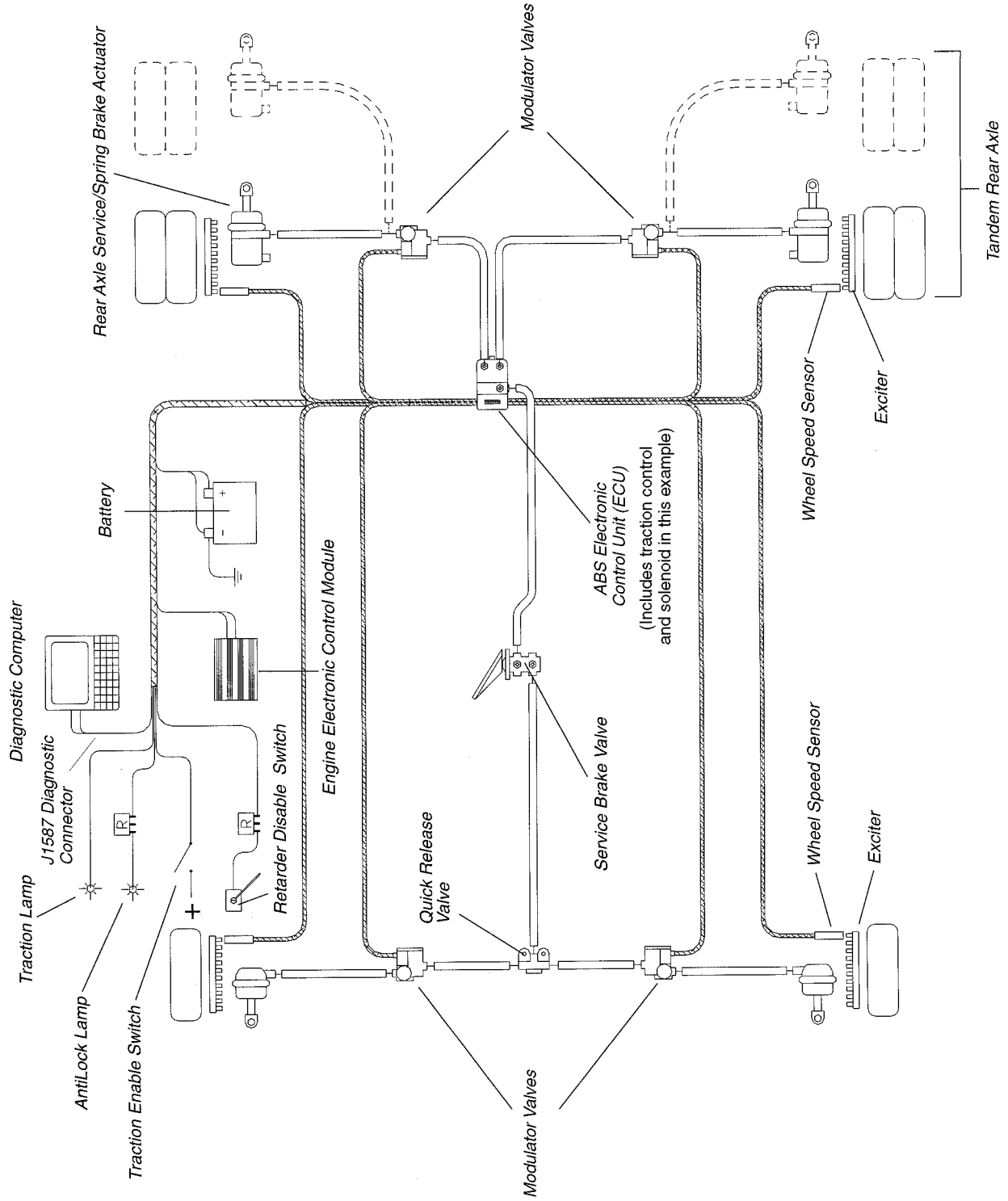

Technicians can communicate with the ECU through a standard SAE J1587 diagnostic connector (See **Fig. 1**). Technicians can read and clear fault codes stored in the ECU and run various diagnostic tests with this connector.

The type of ECU used and its location (in-cab or frame) vary by manufacturer and application. A detailed description of all the different ECU types used today is beyond the scope of this manual. Consult either the vehicle or component manufacturer's service information for specifics.

B. Modulator Valves

ABS modulator valves regulate the air pressure to the brakes during ABS action. When not receiving commands from the ECU, the modulator valve allows air to flow freely and has no effect on the brake pressure. The ECU commands the modulator valve to either:

- change the air pressure to the brake chamber, or
- hold the existing pressure.

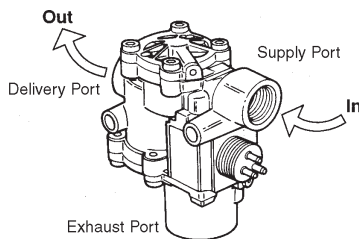

ABS Modulator Valve

However, it *cannot* automatically apply the brakes, or increase the brake application pressure above the level applied by the driver.

The modulator valve typically contains two solenoids. The modulator valve and relay valve may be incorporated into a single unit. The modulator valve may also be separate, inserted into the service line to the brake chamber(s) after any relay valve, located as close as practicable to the chamber(s) itself.

When the modulator valve is separate, it has to control more air flow and, therefore, includes two larger diaphragm valves which are controlled by the solenoids. It usually has three ports: the supply port, the delivery port and the exhaust port.

- The supply port receives air from a quick release or relay valve.
- The delivery port sends air to the brake chambers.
- The exhaust port vents air from the brake chamber(s).

Typically, when an ECU controlling a separate modulator valve detects impending wheel lockup, it activates the solenoids to close the supply port and open the exhaust port. When enough air is vented to prevent wheel lockup, the exhaust valve will close and the ECU will—depending on the situation—either:

- keep the supply port closed to maintain existing pressure, or
- open the supply port to allow brake application pressure to increase and repeat the cycle.

C. Wheel Speed Sensors

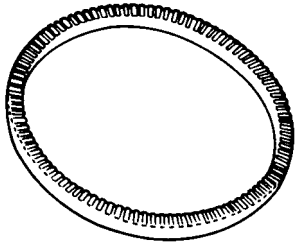

Exciter or Tooth Wheel

The wheel speed sensor has two main components: the exciter and the pickup. Other components include associated wiring and mounting equipment.

Exciter—The exciter is a ring with notched teeth. The most commonly used exciter has 100 evenly spaced teeth, but the number of teeth can vary depending on the system design. The component is known by several names: sensor ring, tooth wheel, tone ring, and exciter.

Pickup—The pickup is commonly called “the sensor.” It contains a wire coil/magnet assembly, which generates pulses of electricity as the teeth of the exciter pass in front of it. The ECU uses the pulses to determine wheel speeds and rates of acceleration/deceleration. The strength of these electrical pulses decreases rapidly with slight increases in the gap between the pickup and the exciter.

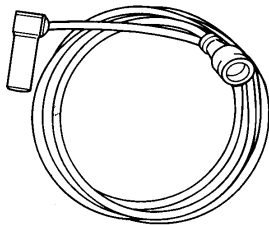

ABS Sensor Pickup

Wheel speed sensor location varies. It can be located anywhere on the axle to sense wheel speed. The sensor can be an assembly containing both the exciter and the pickup with a fixed gap. Or, the pickup and the exciter can be mounted separately on different parts of the axle assembly. The sensor pickup is a sealed unit and typically of elbow or straight design.

On most ABS air-braked vehicles, the pickup is located in the mounting flange on the wheel end. The exciter usually is either mounted on—or integrated with—the wheel hub.

Since the output of the pickup decreases so rapidly with slight increases in exciter-pickup gap, it is imperative that the wheel end and sensor gap be maintained within the manufacturer’s specification.

When the wheels of only one tandem axle have wheel speed sensors, they are usually placed on the axle whose wheels are most likely to lock-up first during braking. On a tandem with a four-spring suspension, the sensors are generally on the lead axle. On a tandem with air suspension, the sensors are generally located on the trailing axle.

ABS configuration is defined by the arrangement and number of sensors and modulator valves used. The most common configurations for power units are:

- four sensors/four modulators (4S/4M),
- six sensors/four modulators (6S/4M), and
- six sensors/six modulators (6S/6M).

Common configurations for trailers are 2S/1M, 2S/2M, 4S/2M and 4S/3M.

D. ABS Malfunction Indicator Lamps

Vehicles required to have an ABS must have ABS malfunction indicator lamps. These lamps must be yellow and light up when the ABS has a “malfunction that affects the generation or transmission of response or control signals” in the ABS.

ABS malfunction indicator lamps are *not required* to light up for every type of malfunction. However, they are required to light up for short periods of time for a bulb check whenever the ABS starts to receive electrical power. The warning lamps for trailers and dollies are not required to light up for a bulb check unless the vehicle is stopped.

All trailers/dollies built on or after March 1, 1998 must feature an external ABS malfunction indicator lamp as part of the ABS. All new trailers must be capable of activating an in-cab trailer warning lamp beginning in March 2001. The requirement for an external trailer/dolly indicator lamp expires in March 2009.

In-cab ABS indicator lamps are typically located on the instrument panel. The exact location and appearance vary by vehicle/component manufacturer. Consult the manufacturer’s service information for specifics.



ABS In-cab Malfunction Indicator Lamp

E. ABS Diagnostics

Although not required by law, all air brake ABSs have self-diagnostic capability. On truck-tractors and single-unit or straight trucks, an ABS provides this information to technicians through the malfunction indicator lamp and/or an electronic diagnostic tool, which plugs into an on-board diagnostic connector. The connector is typically located inside the tractor cab just underneath the left end of the instrument panel. It is usually the same connector that’s used to troubleshoot electronic engines.

Truck-tractors and trucks may also use the ABS malfunction indicator lamp to signal stored fault information through a blink code. Vehicles using this system have a switch to activate the

blink code system. Other ABSs may also have light-emitting diode (LED) lamps on the ECU to indicate problems.

ABSs used on trailers sometimes have a place to connect an electronic diagnostic tool. The connector is either on a pigtail to the ECU, on the outside of the ECU, or inside the ECU box. Others have either LED lamps on the ECU box or number codes displayed inside the ECU which give diagnostic information.

F. Traction Control Systems

Traction control systems are designed to prevent wheel spin in the power mode.

Unlike an ABS, traction control *can* apply the brakes automatically. The driver does not need to depress the brake pedal for traction control to engage.

Traction control is not required by law, but it is a common ABS option.

Traction control systems are designed to prevent wheel spin in the power mode. Traction control attempts to regain traction by braking the spinning wheels, and sometimes throttling back engine power. Unlike an ABS, traction control *can* automatically apply the brakes. The driver does not need to depress the brake pedal for traction control to engage.

Traction control electronics are integrated into the ABS ECU. The system applies the brakes on the spinning wheel(s) when the wheel speed sensors tell the ECU that a wheel is accelerating at a much faster speed than the wheel on the other end of the axle. It does this by energizing a solenoid valve, which directs reservoir pressure to the relay valve and simultaneously activates the modulator valves to keep air pressure from the brake chambers. The ECU then directs the modulator valve to open, and pulse air into the brake chamber on the spinning wheel until wheel speed balance is regained.

On some systems, the ECU will throttle back engine power if both wheels are spinning too fast. If all the drive wheels on a tractor are spinning too fast, the tractor can become unstable, spin or jackknife. Traction control is especially valuable when a light drive wheel load might allow the wheels to spin under power, or when a tractor is pulling multiple trailers.

III. ABS TROUBLESHOOTING, MAINTENANCE & INSPECTION

Although an ABS generally requires no routine maintenance, it should be checked periodically like other components of the air brake system.

In this section, we review various aspects of ABS troubleshooting, maintenance and inspection. When you complete this section, you should understand:

- General ABS troubleshooting principles
- Special concerns about connector repairs
- ABS error detection methods
- Common ABS errors and causes
- General ABS component adjustment, installation and removal procedures

A. ABS Troubleshooting

1. *General Diagnostic Principles*

This section describes general principles of electrical, electronic, and air system diagnostics to provide technicians with a plan of action for ABS troubleshooting. **Chart 1** on page 15 illustrates these diagnostic principles in flow chart form. The following sub-sections—based on The Maintenance Council’s Recommended Practice TMC RP 1406, “Basic Electrical/Electronic Diagnostic Procedures”—cover this process in detail.

Step 1: Verify the problem or driver concern.

Establish the connection between the symptom and the underlying cause of the problem. Use the vehicle manufacturer’s recommended information collection methods for verification.

Step 2: Perform preliminary checks.

Operational, visual and audio checks are generally easy to perform, do not require the use of special tools and may result in a quick diagnosis. This is a critical step in the diagnostic process.

CHART 1: GENERAL DIAGNOSTIC PRINCIPLES

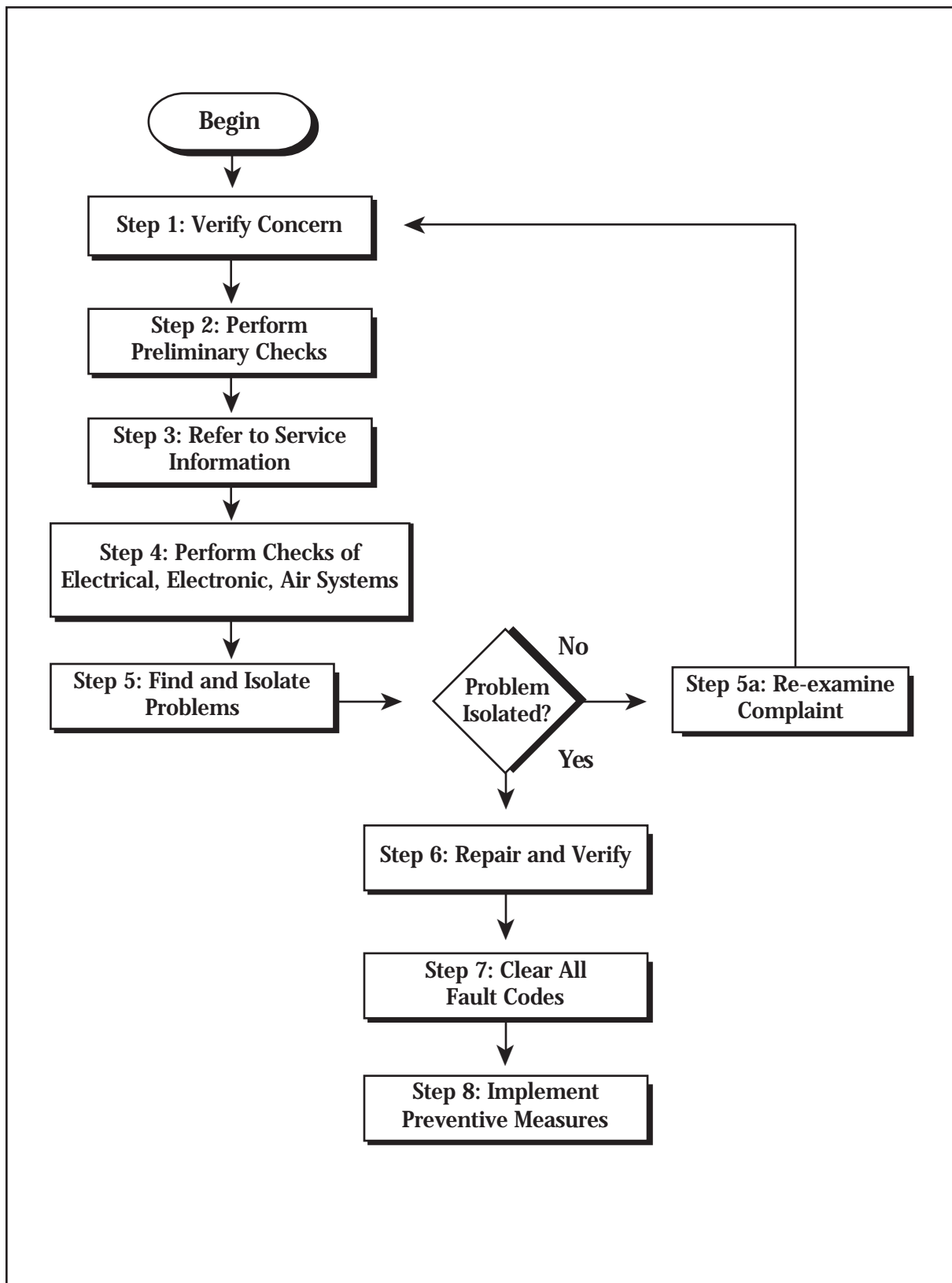

Step 3: Refer to service information.

Vehicle manufacturers provide service procedures which must be followed to ensure proper repair. Training/service information is readily available from various sources such as:

- Bulletins
- Service newsletters
- Videotapes
- Service manuals
- Manufacturers' and dealers' "Help Line Phone Numbers"
- Troubleshooting guides

Be sure to confirm that the reference material is applicable to the specific problem or vehicle being diagnosed. Also, ensure information is current. Vehicle and supplier manufacturers' service information—specifically bulletins and newsletters—is very effective and may help shorten diagnosis.

Hands-on training may also be available from the vehicle/ABS manufacturer at dealer locations or on site at the fleet. The *Brake Training Resource Directory* contains a list of brake training resources in North America. It is available from the Office of Motor Carriers, Federal Highway Administration, 400 7th St., S.W., Washington, DC 20590, (202) 366-4009 or from The Maintenance Council by calling (800) ATA-LINE or (703) 838-1763.

Step 4: Perform electrical, electronic and air system checks.

Systems checks found in service manuals provide a systematic approach to identifying the probable cause of a system fault. This step is important to properly define the correct approach for the repair and to avoid unnecessary time-consuming repairs. Additionally, systems checks will help to define what the problem is *not*. Systems checks may require the use of original equipment manufacturer (OEM) service tools and should isolate a particular component in the system as a probable cause.

i. Electrical diagnostic procedures

Electrical problems are a common cause of ABS faults. It is beyond the scope of this document to explain electrical diagnostic procedures for all ABSs and vehicle manufacturers in great detail. References for diagnosing electrical systems can be readily obtained from component, vehicle, and test equipment

manufacturers. (TMC Recommended Practice 129, “Heavy-Duty Vehicle Systems Wiring Checks,” is a good source of general information on electrical diagnostic procedures.)

ii. Electronic diagnostic procedures

To diagnose an electronic system properly, specialized test equipment approved by the electronic system manufacturer may be required. Failure to use the correct diagnostic tool may result in inaccurate or incomplete diagnosis or cause ECU damage.

iii. Air system diagnostics

It is beyond the scope of this document to explain air system diagnostic procedures in great detail. However, several TMC Recommended Practices—such as RP 619, “Air System Inspection Procedure”—are a good source of general information on this topic. Other references for diagnosing air brake systems can be readily obtained from component, vehicle, and test equipment manufacturers.

Chart 2 on page 18 is an example of a troubleshooting flow chart for a common modulator valve problem.

Technician Tip—

If a suspect part can be easily installed and removed, remove and temporarily replace it with a known good part to see if the problem remains.

If the problem disappears, reinstall the suspect component to see if the problem returns. If so, replace the suspect component.

Step 5: Find and isolate problem

For an active problem, the diagnosis should narrow and/or eliminate possible causes. Find and isolate the faulty part of the system or circuit by breaking the problem into smaller pieces. For an intermittent problem, attempt to simulate/recreate the conditions where the fault would exist. Monitor suspect circuits and components to pinpoint the probable cause while the problem is occurring.

Step 5a: Reexamine complaint

Review all information describing the complaint. When did the problem occur? What conditions are present when the symptom occurs (weather conditions, driving conditions, etc.)? Contact the driver, if necessary, to gather more information or to arrange a “show me” or test drive interview.

Step 6: Repair and verify

Once the suspect component is found, carefully disconnect the old component and inspect its connections to the harness. If the component connections are OK, temporarily connect a known good component (without installing) to ensure the problem is corrected.

After the problem is corrected with the known good component, reconnect the suspect component to make sure the problem returns. Temporarily connecting a known good component, and then reconnecting the suspect component, will help reduce replacement of incorrect components. If reconnecting the suspect component does not cause the problem to recur, thoroughly inspect the connectors and harnessing for the cause of the problem. Reconnect the suspect component and move (jiggle) the harness while monitoring for the problem to return. If the problem returns with the connection of the suspect component, permanently install the new component.

CHART 2: SAMPLE ABS MODULATOR VALVE PROBLEM FLOW CHART

Chart 2 represents a typical troubleshooting flow chart for a common ABS modulator valve problem.

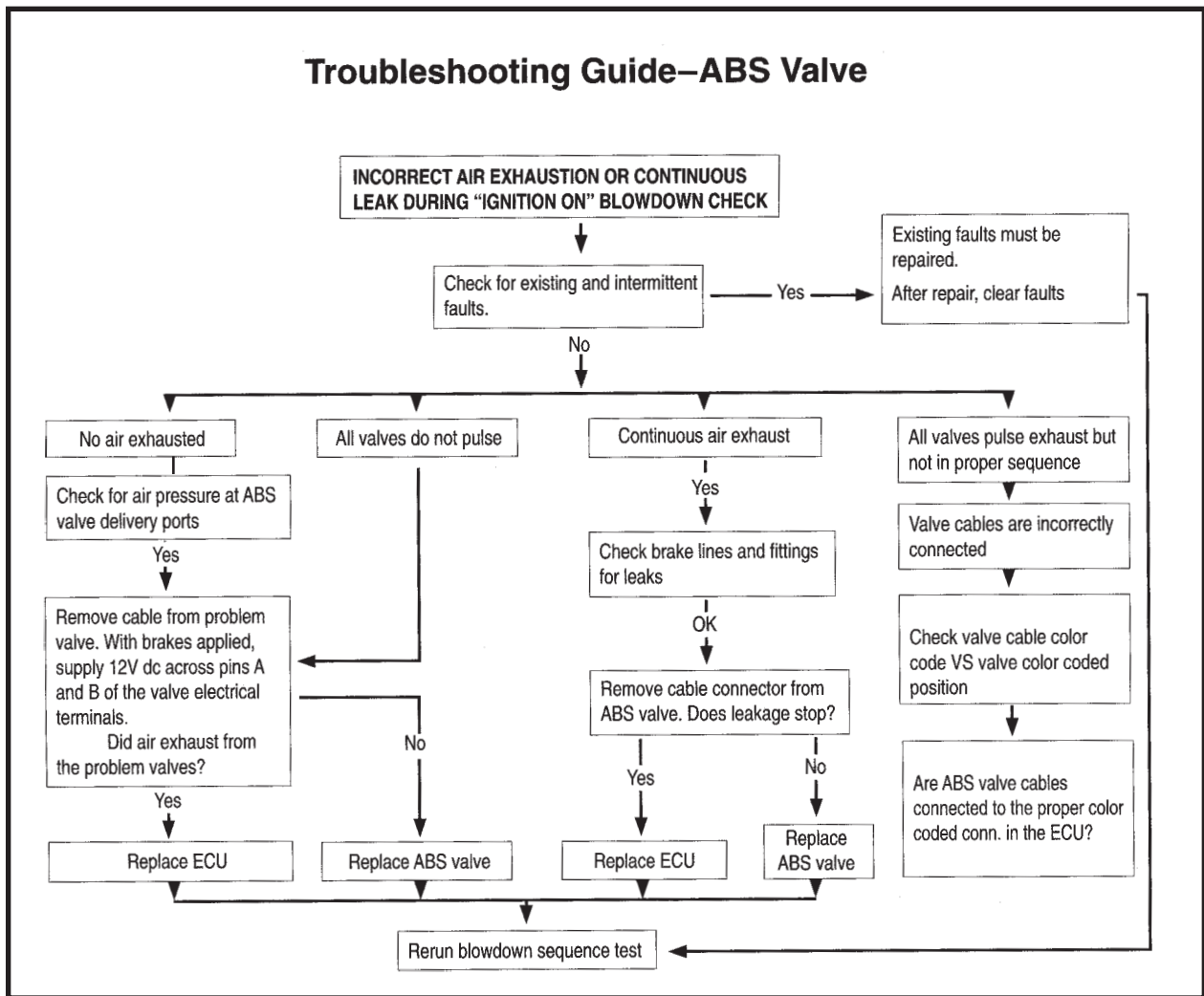

Step 7: Clear fault codes.

Clear any codes stored in the ECU identifying the problem.

Step 8: Implement any possible preventive measures.

Review the vehicle maintenance schedule for required service intervals and perform necessary maintenance. Check for other areas of apparent concern and notify the fleet manager—or fix—prior to release of vehicle.

2. Notes on Electrical/Electronic Connections

The following section contains general service information that should be considered if electrical/electronic connections need repair during ABS servicing.

a. Wiring Termination Techniques

Termination is the process of either ending a wire or attaching a device to be used at the end of a wire. Wiring terminations are made in a variety of ways. Wires can be terminated with butt splices, the application of a terminal, and by simply “tinning” or sealing the wire’s end.

The primary considerations during a termination are mechanical strength, vibration resistance, electrical integrity, and environmental protection.

- *Mechanical Strength*—Whenever a wire is terminated, the mechanical strength of the termination should meet or exceed the mechanical strength of the conductor without the termination.
- *Vibration Protection*—Always place conductors back in any holding device that they were in prior to the modification/repair or attach the conductors to the vehicle in a manner which will prevent the conductor from vibrating during operation.
- *Electrical Integrity*—The termination must be able to fulfill the electrical needs of the circuit (for example, current-carrying capability, minimal voltage drop). Whenever a termination or splice is made in a conductor, an inherent voltage drop will be present. Special connectors are available to minimize the voltage drop, but these connectors normally are cost prohibitive. Terminations made carefully normally provide an acceptable voltage drop.

- *Environmental Protection*—Whenever a termination is made in a conductor which disturbs the integrity of the insulation on the conductor, measures must be taken to ensure that the termination is not susceptible to moisture damage or other damage which may result from the conductor or termination being exposed to its normal operating environment. Additionally, consideration must be given to the type of insulating material being used to ensure that it has an acceptable heat range and is compatible with the intended environment.
- *Electromagnetic/Radio Frequency Interference Protection*—The ECU contains components that can detect radio waves and other electromagnetic “noise” and unintentionally send false signals because of them. To prevent radio frequency interference (RFI) and electromagnetic interference (EMI), ABS cables contain special shielding. When making repairs, take care to ensure the integrity of the shielding is not compromised.

For terminations that are made to a threaded stud which is exposed to salt spray or other corrosive environments, a suitable coating material should be applied to the connection to ensure adequate service life.

Conventional Terminations—Conventional terminations are terminations made using commercially available terminals such as ring terminals, spade terminals, etc. Terminals of this type are available through many different outlets.

Selection of good quality terminals is crucial to making a dependable connection. The selection should include the considerations mentioned in “Wiring Termination Techniques,” as well as specific considerations about the location of the termination on the vehicle (for example, heat exposure). Some fleets have established specific methods for making terminations. These methods were developed to ensure consistent terminations which will yield an acceptable service life. These recommendations should be followed when applicable.

Proprietary Terminations—Proprietary terminations are terminations made using proprietary terminals and connector

bodies. These terminations are very common on commercial vehicles and come in a variety of configurations. Multiple connections in one connector body are typical. Also, various types of proprietary terminations on the same vehicle are common. When repairing or replacing these terminations, special techniques are needed. These techniques include tools, special assembly methods and, many times, special training.

When servicing special connectors, use of OEM recommended tools is critical to making a good termination. Repair or replacement of these special terminations should not be attempted without the specific tools recommended. Manufacturers' service manuals and bulletins typically detail the techniques to be used for proper repair.

Butt Splices—A butt splice is any splice where wires are joined together “end-to-end.” In this case, the wires may be either twisted together and soldered, or crimped together using a commercially available terminal. Butt splices should always be covered with insulation and heat shrink tubing which has a meltable inner liner or another suitable protective insulation. The use of pressure sensitive tape is not recommended as the tape will likely deteriorate with time.

Conductor Terminations—Terminations of conductors are made to attach the conductor to another conductor or to a device on the vehicle. These terminations must be carefully made in order to provide acceptable serviceability. Attaching a wire to another wire (not using a butt splice) is an example of a conductor termination.

Terminations Without Terminals—Occasionally a wire is terminated without a terminal to facilitate the attachment of the wire to an accessory. If this situation is unavoidable, the wire should be “tinned” to prevent fraying and breakage at the point of connection. Using a heat shrink process at the end of the wire is also acceptable.

Technician Tip—

Whenever an additional grounding point is to be established on the vehicle, consult the vehicle manufacturer to ensure that the planned alteration does not result in an inadequate ground path for other components on the vehicle.

b. Grounding Recommendations

Grounding problems occur in a variety of ways (such as corrosion or inadequate current-carrying capacity). As a result, grounding terminations should be coated with a suitable material to prevent corrosion as a result of exposure to salt spray or other corrosive environments.

Whenever an additional grounding point is to be established on the vehicle, consult the vehicle manufacturer to ensure that the planned alteration does not result in an inadequate ground path for other components on the vehicle. This is especially important when establishing a grounding point between chassis and body.

c. Wiring Damage Caused During Repair

Mechanical damage to wiring must be avoided during vehicle repair. Insulation cuts and “pinch points” are common problems which may cause failure.

Conductor insulation should not be pierced while troubleshooting electrical problems. Piercing of the protective covering results in corrosion which can cause circuit failure. If piercing of the insulation is unavoidable, suitable insulation to avoid water entry must be used at the point where the conductor was pierced.

d. Vehicle Repairs—Special Care

Many times vehicle repairs include welding operations. All welding on a vehicle should be done using methods and techniques which are acceptable to the OEM in order to avoid damage to the electrical and electronic system of the vehicle. This damage normally occurs due to unwanted circuit paths or to voltage spikes created in the electrical and electronic systems which cause component failure.

CAUTION: When welding on an ABS-equipped vehicle, disconnect power and ground leads from the ECU to avoid unintended grounding through the ECU which will damage electronic components. Other damage may occur to vehicle systems as a result of heat generated during the welding process. Special care must be taken to ensure that heat buildup does not melt conductors and other susceptible electrical components.

e. Miscellaneous

The use of “star washers” in the electrical path is discouraged. Often, an open circuit or high resistance results when the “points” of the washer are exposed to salt spray and other corrosive materials. If the use of star washers cannot be avoided, a suitable material should be applied to the connections to ensure as much protection from corrosion as possible.

3. Error Detection Methods

One ABS benefit is the ability to electronically detect component or system failures. This electronic detection occurs either during self-test checks at start-up, or during continuous passive monitoring.

At start-up, the ECU will activate the ABS malfunction indicator lamp and briefly energize the ABS modulator valves (ignition-on blowdown or “chuff test”). At the same time, the ECU checks the wheel speed sensors and other essential components for proper operation. If no problems are found, and the ECU detects that wheel speed sensors were functioning properly just prior to the last vehicle shutdown, the ABS malfunction indicator lamp will go out. On earlier systems, the lamp would not go out until the vehicle reached about 5 mph.

During vehicle operation, the various ABS components also continually monitor each other for failures and “out-of-range” operating parameters. Through this process, the ECU detects abnormalities during operation and activates the ABS malfunction indicator lamp as appropriate.

The ECU will generally detect two types of faults: active and stored. An active fault is a current and continuous failure in need of repair (such as a broken connector). A stored fault is a failure that affects ABS operation intermittently (such as a loose connector). Technicians typically can retrieve failure information either through blink codes or an electronic diagnostic tool. For explanations of manufacturer-specific diagnostic and troubleshooting tools and procedures, consult the appropriate manufacturer’s service information.

Top 10 Most Commonly Encountered Problems That Trigger ABS Malfunction Indicator Lamps

1. Abraded or cut wires in convoluted tubing near frame clamps.
2. Cut or corroded wires near sharp frame members and frame-mounted modulators.
3. Wire jacket worn through from overlapping sensor and modulator wires near frame members and frame-mounted modulators
4. Corroded connectors and connections not properly sealed or damaged seals.
5. Damaged connector latches or connectors not completely sealed to mating assemblies.
6. Terminals not completely latched or seated into connectors
7. Excessive sensor air gap, sensor clip tension or excessive wheel bearing endplay.
8. Damage to exposed wires exiting or entering wire tubing.
9. Worn, chipped or damaged sensor or modulator.
10. Non-functioning controller (ECU).

CHART 3: SAMPLE ABS MALFUNCTION INDICATOR LAMP (WARNING LIGHT) DIAGNOSTIC FLOW CHART

NOTE: The notations to various sections that appear in Chart 3 refer to the source document from which this chart originally appeared—not this manual. Chart 3 represents a typical ABS warning light diagnostic flow chart.

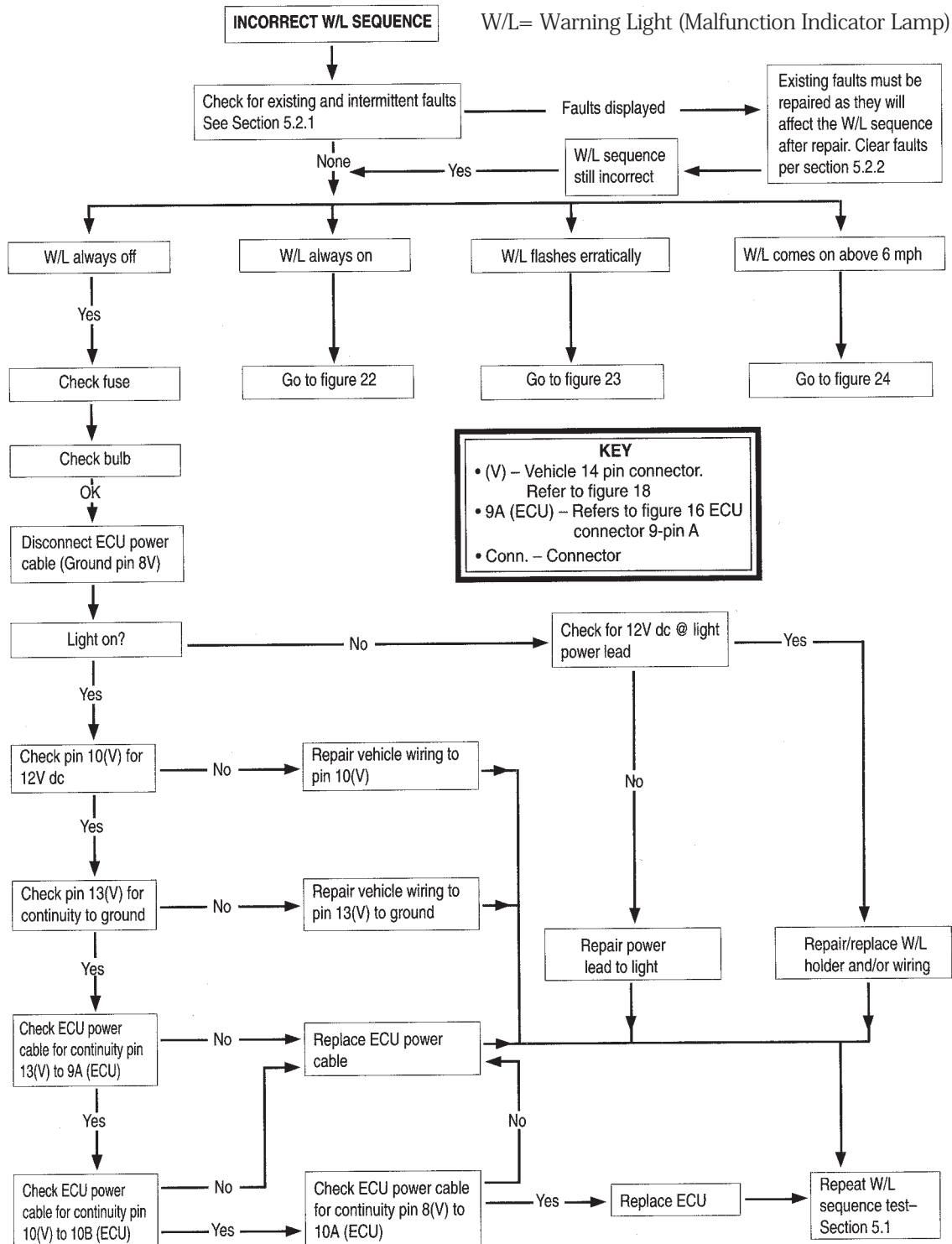

TABLE 2: COMMON ABS ERRORS AND RESPONSES	
DETECTED ERROR	SYSTEM RESPONSE
Component or wiring failure	ABS malfunction indicator lamp informs driver of fault. Affected wheel(s) is removed from ABS control and switched to normal braking. The remaining ABS valves may continue providing braking control at the wheels. The error is recorded as a fault code and stored in the ECU. The information can be recalled by the technician through the blink code lamp or an electronic diagnostic tool.
Power supply to ECU is interrupted or ABS connector not plugged in.	All antilock and traction control systems would be inoperative. Normal, non-ABS controlled braking would be available at all wheels. ABS malfunction indicator lamp indicates system fault.
Individual electronic component fails internally in ECU.	All or part of the ABS is shut off and that part of the vehicle reverts to normal, non-ABS braking. ABS malfunction indicator lamp indicates system fault.
Error not detected. ABS remains inoperative but warning light remains off	Certain failures, mainly mechanical, can occur and cause the ABS to malfunction but not illuminate the indicator lamp. Depending on the fault, the ABS will be inoperable on one or more axles. In the rare event a valve hangs open, system air could be lost, impairing all braking.

Chart 3 on page 24 shows an ABS indicator lamp diagnostic flow chart. **Table 2** on page 25 offers a list of common ABS errors and responses.

4. Causes of Common ABS Sensor Problems

Table 3 on page 26 summarizes the causes of several common ABS sensor problems.

One benefit of monitoring wheel speed with a exciter ring/sensor system is that dirt or dust does not affect operation.

TABLE 3: COMMON ABS SENSOR PROBLEMS AND CAUSES

PROBLEM	CAUSE
Sensor signal is erratic.	Damaged tooth wheel, excessive hub runout, and/or sensor gap is too wide. Replace as needed. Check sensor adjustment, resistance. Check wheel bearing adjustment.
Open sensor circuit.	Damaged sensor, cable or loose cable connections. Replace as needed.
Shorted sensor circuit.	Damaged sensor, cable or cable connections. Replace as needed.
One sensor is not producing a signal when other sensors are producing signals, and sensor resistance is within specification.	Improper air gap at non-producing sensor. Gaps should not exceed 2 mm (0.080 in.). Check sensor adjustment. Check wheel bearing adjustment.
ABS malfunction indicator lamp does not go out when vehicle reaches speed needed for minimum or “threshold” voltage (such as five mph.)	All of the items listed above could be causes. Also, no tooth wheel or sensor installed. Install tooth wheel and sensor.
Sensor cap and cables lose elasticity, swell, or become mechanically sensitive.	Corrosion of bushing, sensor, and/or sensor clip. Make any necessary replacements. Check manufacturer’s recommendations for proper lubricant.

Even if the space between the teeth of the exciter ring is full of dust and particles from the brake linings, the monitoring operation is not affected. In fact, the magnetic property of the dirt in the gaps is similar to that of air. The change in the magnetic field is determined by the spacing of the teeth of the exciter ring. The output voltage is unaffected by dirt.

Therefore, an ABS fault cannot be remedied by cleaning the tooth wheel with compressed air. Dirt in the gaps doesn’t affect voltage output, so removing it will not remedy an ABS fault.

B. ABS Maintenance and Inspection

1. ABS Sensor Pickup Adjustment

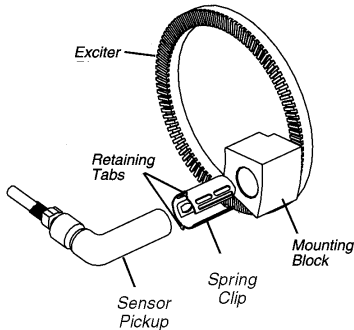

Typical Sensor Assembly

CAUTION: Follow all recommended safety warnings and cautions. To prevent eye injury, always wear safe eye protection when performing maintenance or service. Do not work under a vehicle supported only by jacks. Jacks can slip or fall over and cause serious personal injury.

To adjust the ABS sensor pickup, gently push the sensor pickup in until it contacts the tooth wheel:

- On the steering axle, the sensor pickup may be accessible on the in-board side of the steering knuckle.
- On the drive axle, the wheel and drum assembly must be pulled to gain access to the pickup. Prior to pulling the wheel and drum assembly, observe the output voltage of the pickup while rotating the wheel by hand. The amount of output voltage is dependent upon the sensor pickup gap and wheel speed. Refer to the manufacturer's recommendations for proper voltage levels.

2. ABS Sensor Pickup Removal & Installation

The following installation and removal procedure is a guideline only. When removing or installing a sensor pickup on your system, always follow the procedures detailed in the manufacturer's maintenance manual.

3. Sensor Pickup Removal—Front Axle

To remove the sensor pickup from the front axle:

1. Put wheel chocks under the rear tires to keep the vehicle from moving. Apply the parking brake.
2. Remove the pickup and spring clip from the steering knuckle. Use a twisting motion if necessary. Never pull or tug on the cable.
3. Disconnect the pickup cable from the chassis harness. Be careful not to criss-cross wiring.

4. Sensor Pickup Installation—Front Axle

To replace the sensor pickup in the front axle:

1. Connect the sensor cable to the chassis harness. Be careful not to criss-cross wiring.

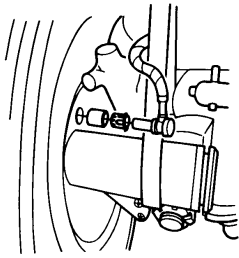

Sensor Pickup Removal/ Installation: Front Axle

2. Install the fasteners used to hold the sensor pickup cable in place.
3. Apply lubricant to the sensor spring clip and to the body of the pickup. **NOTE:** Use a mineral oil-based lubricant that contains molybdenum disulfide. The lubricant should have excellent anti corrosion and adhesion characteristics, and be capable of continuously functioning in a temperature range of -40° to 300° F (-40° - 150° C).
4. Clean and inspect the hole in the steering knuckle. Install the sensor pickup spring clip. Make sure the flange stops are on the inboard side of the vehicle.
5. Push the sensor spring clip into the bushing in the steering knuckle until the clip stops.
6. Push the sensor pickup completely into the sensor spring clip until it contacts the tooth wheel/exciter.
7. Install fasteners and straps to retain the pickup wiring.
8. Remove the wheel chocks.

5. Sensor Pickup Removal—Rear Axle

1. Put chocks under the front tires to keep the vehicle from moving.
2. Raise the rear tire off the ground. Put safety stands under the axle.
3. Release the parking brake and back off the slack adjuster to release the brake shoes.
4. Remove the wheel and tire assembly from the axle.
5. Remove the brake drum.
6. Remove the pickup from the mounting block in the axle housing. Use a twisting motion if necessary. Never pull or tug on the cable.
7. Remove the sensor spring clip from the mounting block.
8. Disconnect the fasteners that hold the sensor cable and the hose clamp to the other components.
9. Disconnect the pickup cable from the chassis harness.

6. Sensor Pickup Installation—Rear Axle

To reinstall the sensor pickup in the rear axle:

1. Apply lubricant to the sensor spring clip and to the body of the pickup. Follow manufacturer's recommended lube

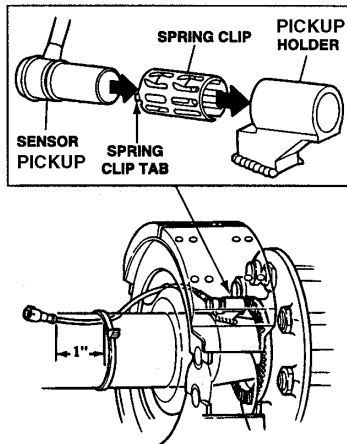

**Sensor Pickup Removal/
Installation: Rear Axle**

specification (See lubricant recommendation in previous section “ Sensor Pickup Installation—Front Axle”).

2. Clean and inspect the hole in the mounting block. Install the sensor spring clip. Make sure the flange stops on the inboard side of the vehicle.
3. Push the sensor spring clip into the mounting block until it stops.
4. Push the pickup completely into the sensor spring clip until it contacts the tooth wheel. See figure at left.
5. Insert the pickup cable through the hole in the spider and axle housing flange. Route the cable to the frame rail. Be sure to route the cable in a way that will prevent pinching or chafing, and will allow sufficient movement for suspension travel.
6. Connect the pickup cable to the chassis harness.
7. Install the fasteners that hold the pickup cable in place.
8. Install the brake drum on the wheel hub.

7. Proper ABS Sensor Resistance

For most common types of ABS sensors, the sensor circuit resistance is between 700-3000 ohms. Resistance can be measured at the sensor connection when it is removed from the ECU, or right at the sensor when the extension cable is removed. Follow the manufacturer’s specifications to determine the correct sensor resistance.

8. Modulator Valve/Routine Inspection

As part of a routine vehicle preventive maintenance program, ABS modulator valves should be checked for proper operation and condition. This inspection generally should include:

1. Removal of contaminants and a visual inspection for excessive corrosion and physical damage.
2. Inspection of all air lines and wiring harnesses for signs of wear or physical damage.
3. Testing for leakage and proper operation.

For specific modulator valve inspection and testing procedures, consult the manufacturer’s service information.

9. Modulator Valve Removal and Installation

The following removal and installation information is offered as a guideline only. Always refer to the manufacturer's specific instructions when removing or installing ABS modulator valves.

Removal

1. Disconnect the harness connector from the modulator valve. Be careful not to criss-cross wiring.
2. Disconnect the air supply and air delivery lines from their respective ports.
3. Remove modulator valve mounting fasteners.
4. Remove the modulator valve.

Installation

1. Install the modulator valve with appropriate mounting fasteners. Tighten to specified torque.
2. Connect the air supply and air delivery lines at their respective ports.
3. Connect the harness connector to the modulator valve. Be careful not to criss-cross wiring.
4. Check installation by applying the brakes, listening for leaks at the modulator valve.
5. Turn the ignition on, and listen for the modulator valve to cycle. If the valve fails to cycle, check the electrical connection and any stored or active fault codes. Drive the vehicle to verify that the ABS and its malfunction lamp operate properly.

10. Proper ABS Modulator Valve Resistance

For most ABS modulator valves, the resistance range between each valve solenoid coil terminal and the ground on the ABS valve connector is between 3-10 ohms. To test this resistance, disconnect the wiring connector from the modulator and test the resistance between the two pins of each solenoid. Follow the manufacturer's instructions for determining valve resistance.

IV. ABS SPEC'ING CONSIDERATIONS

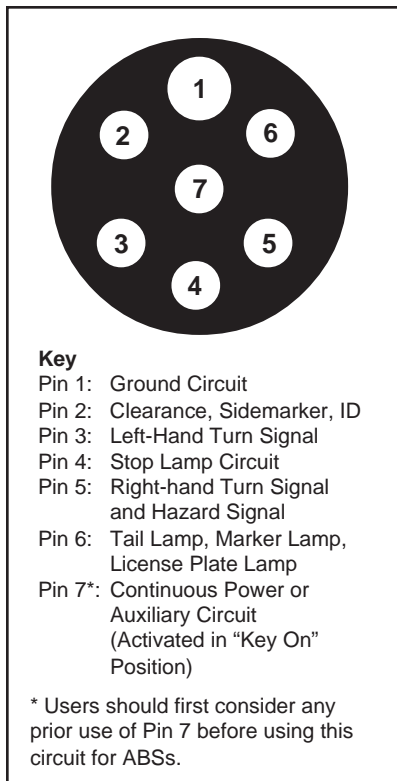

Trailer Seven-Pin Receptacle Schematic, Using Pin 7 as a Continuous Power Circuit for ABSs

The Federal Government's requirement for full-time electrical power to ABSs has prompted both equipment users and manufacturers to reconsider the way trailers are supplied with such power. Since a particular powering configuration is not required in the ABS rule, manufacturers and equipment users can decide for themselves how to achieve the full-time power requirement.

There are several different methods of supplying full time power to the trailer ABS:

- If the auxiliary circuit of the seven-pin connector is not in use, it can be used to supply full-time power as long as the circuit is always "on" or "hot" when the key switch is "on." **NOTE:** Unless otherwise specified, many manufacturers will supply a "hot" auxiliary circuit as standard equipment. It is very important that vehicles use this option if they are commonly coupled to vehicles in other fleets.
- A second connector can be used specifically to power the trailer ABS. (for example, the ISO 3731 connector)
- A special connector which is compatible with the existing seven-pin connector can be used if it can accommodate additional circuits (for example, a 13-pin connector).

Each of these methods has certain advantages and drawbacks. However, it is the consensus of the members of The Maintenance Council that the existing seven-pin connector design should be preserved if possible for important reasons of compatibility, safety, and maintainability.

Another important consideration is ensuring that adequate power is available for proper ABS function. Voltage drops between the battery and the last unit of a combination vehicle can impact the amount of power available for the ABS, especially in doubles and triples combinations.

For these reasons, TMC developed two recommended practices to promote power supply and connector standardization—TMC RP 137, "Antilock Electrical Supply From Tractors Through the SAE J560 Seven-pin Connector," and TMC RP 141, "Trailer ABS Power Supply Requirements."

To ensure adequate power is provided to the trailer from the tractor, TMC RP 137 recommends that at least 12.5 volts be available at the J560 connector with a 10-amp load on both the

stop lamp and auxiliary circuit. Industry consensus is that meeting this minimum recommendation will ensure adequate power for trailer ABSs.

Additionally, TMC RP 141 recommends that:

- Pin 7 of the J560 connector be reassigned as a continuous power circuit, activated when the ignition is on.
NOTE: For the purposes of RP 141, Pin 7 of the SAE J560 seven-pin connector (so designated by SAE as the auxiliary circuit) is referred to as the continuous power circuit.
- There be a minimum of 9.5 volts (which includes a 1-volt safety margin) available at the trailer ABS ECU—when coupled to a tractor complying with RP 137— to ensure adequate power for proper ABS operation.
- Trailer manufacturers provide equipment purchasers with written information regarding the voltage and current characteristics of the stop lamp and auxiliary circuits at the SAE J560 seven-pin receptacle. TMC recommends this information be included in the owner's manual.

TMC does not recommend specific wiring gauge sizes, lighting technology, ABS power consumption, or grounding methods. It is the consensus of TMC's membership to leave those decisions to the manufacturer/equipment user.

All vehicle/component manufacturers have agreed to incorporate TMC's recommendations into their vehicle design as either standard or at the request of the equipment user.

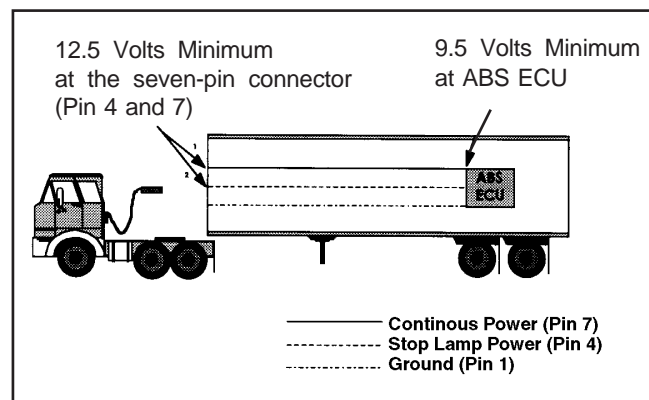

**Recommended Minimum Voltage for ABS
As Specified by TMC RPs 137 and 141**

V. GLOSSARY OF ABS TERMS

The following terms are used by one or more manufacturers to describe different aspects of ABSs:

Antilock Braking System (ABS)	A system that monitors and controls wheel speed during braking so as to minimize wheel lockup while maximizing vehicle lateral stability. Plural form—ABSs.
ABS Configuration	The arrangement of antilock braking system components, which varies by the number of sensors and modulator valves used. The following configurations for tractors are commonplace: 4S/4M, 6S/4M, and 6S/6M. For trailers, 2S/1M., 2S/2M, 4S/2M and 4S/3M. (S= sensor. M= modulator.)
ABS Inline Valve	A modulator valve located in the service brake delivery line near the wheel's brake chamber which modifies brake pressure during an ABS event. Also see ABS Modulator Valve or ABS Relay Valve.
ABS Modulator Valve	An electro-pneumatic control valve that contains the solenoids used to precisely modulate brake air pressure during an ABS event. Also see ABS Inline Valve or ABS Relay Valve.
ABS Relay Valve	A valve that performs the service relay function as well as the ABS modulator valve function to modify brake air pressure during an ABS event. Also see ABS Modulator Valve or ABS Inline Valve.
Anti-Spin Regulation (ASR)	See Traction Control.
Automatic Traction Control (ATC)	See Traction Control.
Axle Control	That mode of ABS control whereby one modulator controls the air pressure to the brake chambers on both ends of a given axle. Also referred to as axle-by-axle control.
Bracket Mounting	The means of installing the ABS modulator-controller on the host vehicle by using a supplied, pre-formed bracket.

Brake Proportioning	The limiting of brake air pressure to a specific axle or tandem to compensate for varying vehicle loading. Brake proportioning is most beneficial during bobtail tractor operation.
Braked Wheel Behavior	The study of wheel reactions during braking, particularly between the road surface and the tire.
Category (I, II, & III)	A means of categorizing ABS performance used in Europe.
Chamber Pressure	The air pressure in the brake chambers during a brake application.
Channel	The electrical connection between the ECU and the modulator. The term is also used to describe the number of individual modulators in a particular antilock system.
Chuff Test	Also called ignition blowdown test. A test—designed to simplify diagnostics—used to exercise the ABS modulator(s) upon initial power-up. The “chuff” sound is made by air escaping from rapid exercising of the exhaust solenoid (and supply solenoid) on each modulator.
Coefficient of Friction	A measure of the friction (such as between a tire and the road surface) available to use as surface retardation. The ratio is defined as “Force Required to Overcome Friction/Weight” and is denoted by the Greek letter μ . See also “Mu.”
Control Algorithm	The specific configuration of logical decisions implemented to determine the characteristics of an ABS cycle. Apply, release, hold, etc., determinations are made in the control algorithm, which is implemented in the ABS software contained in the electronic control unit (ECU).
Control Pressure	The air pressure applied from the foot/hand valve which controls the brake application pressure either directly or through a relay valve. The ABS interrupts this pressure by adding a modulator in series such that the air pressure at the individual brake chambers may vary from the control pressure. During ABS operation, therefore, chamber pressure may be equal to or less than the control pressure.
Controller	Another name for the electronic control unit (ECU). See Electronic Control Unit.

Current	Current represents the flow of electrons through a conducting medium, such as copper. Current is measured in amperes or amps and can be derived through the following formula: Amp = Volt/Ohm or $I = V/R$.
Cycle	A single sequence of pressure application and release during ABS operation. This cycle repeats during an ABS event as long as impending wheel lock-up is identified. Also referred to as “cycling.”
Data Link	The TMC/SAE J1708/J1587 Serial Data Link Standard used in most vehicle-mounted ECUs.
Diagnostics	A method of identifying faulty components or parameters. For example, a series of LED lights may be used to identify specific ABS components that need to be serviced or corrected.
Diagonal Split	The case in which ABS is disabled on both the specific wheel with an ABS failure and its diagonal counterpart to maintain vehicle control during emergency stops.
Dynamic Fault	A fault detected with the wheel speed sensors or modulators when the wheels are rotating. See Static Fault.
Electronic Control Unit (ECU)	An on-board vehicle computer that controls the ABS, traction control and diagnostic functions. The ECU receives input signals, processes the information, and sends output signals to the necessary ABS components.
Electromagnetic Interference	Electromagnetic interference (EMI) disrupts the proper operation of an electronic device or system. EMI is caused by electromagnetic field(s).
EPROM	EPROM stands for Erasable Programmable Read Only Memory. The term refers to an integrated circuit that contains the ABS control algorithm.
Exciter	A metal ring, normally with 100 evenly spaced teeth, although sometimes with 80 or 120 teeth, depending on tire size. It is usually attached to the barrel of the hub on each ABS-monitored wheel. When the wheel rotates, the teeth move past the wheel speed sensor pickup to create an electrical signal that the ECU uses to determine wheel speed. Also called a Tooth Wheel.

Failure Lamp	An indicator lamp that indicates ABS operational status. See Malfunction Indicator Lamp.
FMVSS	Federal Motor Vehicle Safety Standard. FMVSS 121, "Air Brake Systems," is the regulation that applies to air brakes used on commercial vehicles.
Four-Channel ABS	A system that has four sensors and four modulators (4S/4M) or six sensors and four modulators (6S/4M).
Full-Time Power	This term refers to an ABS design in which a circuit connects the tractor and trailer to supply constant electrical power for an ABS. See Stop-lamp Power.
Ghost Sensing	In-axle Speed Sensing Systems where one wheel/axle is sensed and the differential gear is sensed. The ECU uses these two inputs to calculate the speed of the unsensed wheel (i.e., the ghost sensor). Ghost Sensed Speed = (2)(Average) - Individual.
In-Axle Sensor/Sensing	The practice of locating wheel speed sensing devices inside the drive axle housing of the ABS-equipped vehicle. This sensing option offers additional environmental protection for the wheel speed sensor, but presents special service considerations for equipment users.
ISO Connector	A multi-pin tractor-trailer electrical connector used in Europe that meets International Standards Organization (ISO) requirements. This connector carries power, failure lamp status, and serial communications to and from European trailer ABSs. The ISO 7638 connector, for example, provides a dedicated ABS power source for European tractor-trailers. The ISO 3731 connector is used by a North American manufacturer for ABSs as well.
J560 Connector	See Seven-Pin Connector.
J1587	An SAE Recommended Practice for applications dealing with the J1708 serial data bus. This standard deals with the assignment of specific parameter codes including diagnostics and other system attributes. SAE J1587 and J1708 must be used together to fully implement the noncritical data exchange on heavy vehicles. See J1708.

J1708	An SAE Recommended Practice for serial exchange of vehicle-based, noncritical parametric information. This standard establishes the hardware and protocol requirements for the serial data bus. See J1587.
Jackknife	A condition that can occur when either tractor, trailer, or tractor <i>and</i> trailer wheels lose traction and lateral vehicle stability cannot be maintained.
Lateral Stability	The resistance of a vehicle to forces which attempt to change its direction of travel. Maximum lateral stability is achieved at zero percent wheel slip (free rolling travel).
LED	Light-emitting diode used in some ABS diagnostic systems to convey diagnostic information.
Malfunction Indicator Lamp	A lamp that becomes active whenever an ABS is not fully functional. The tractor/truck lamp is on the instrument panel. A trailer/dolly in-cab indicator is not required by law until March 2001. However, an external trailer/dolly indicator lamp is required, effective March 1998. By March 2009, the external lamp will no longer be required. Also called Warning Lamp or Failure Lamp.
Manifold	The central device on which the modulators of a two- or three-channel system may be commonly mounted.
Microcontroller	An application-specific microprocessor geared around a specific control function. Also referred to as “computer chips.”
Modulator	See ABS Modulator Valve.
Mu	Refers to the Greek letter μ which represents coefficient of friction. See Coefficient of Friction.
NHTSA	National Highway Traffic Safety Administration. This division of the U.S. Department of Transportation regulates the safety of new vehicles. NHTSA is the federal agency that requires the installation of ABSs on new commercial vehicles.
Non-Volatile Memory (NOVRAM)	Solid-state electronics capable of retaining electrical information in the absence of system power. This is how diagnostics information is saved in the ABS ECU.

Power Jackknife	A non-braking induced condition whereby the drive wheels of a tractor will spin under engine power, resulting in a loss of lateral stability.
Quick-Release Valve	A commonly used valve located close to a brake chamber that decreases the time required to exhaust air pressure from it.
Reference Speed	An ideal rate of wheel speed deceleration (optimum wheel slip) calculated by the ECU and based on actual wheel speed information at the moment that the ABS is activated. The ECU compares actual wheel speed to the reference wheel speed during an ABS event and adjusts the brake application pressure in an attempt to match the actual wheel speed with the ideal reference speed.
Relay Valve	See ABS Relay Valve for definition as it pertains to ABSs.
Retarder Control	A system which prevents the tractor drive axle(s) from locking on slippery surfaces by disabling the engine retarder during an ABS event.
RFI	Radio frequency interference. A type of electromagnetic interference (EMI) that occurs only in the radio frequency band. See Electromagnetic Interference.
SAE	Society of Automotive Engineers. An organization that sets voluntary engineering standards for automotive and aerospace components, systems, and vehicles. See J560, J1587 and J1708.
Select High	A system design in which ABS bases all control decisions to release or apply brakes to an axle or tandem on the highest measured wheel speed. Under this design, ABS won't start cycling until all sensed wheels experience a tendency to lock.
Select Low	A system design in which the ABS bases all control decisions to release or apply brakes to an axle or tandem on the lowest measured wheel speed. If only one wheel locks, the ABS on all other controlled wheels on that axle or tandem will also cycle.
Sensor Bushing	The friction spring device that is first inserted into the sensor block, allowing the sensor pickup to be adjusted and holding it in position during vehicle operation. Also called a spring clip.

Seven-Pin Connector	An electrical connector used between units of combination vehicles in North America to conduct electrical power for the Stop Lamps, Turn Signals, Running Lamps, Ground, and Auxiliary (or ABS) circuits. Also known as the SAE J560 connector
Side-by-Side Control	A control system that uses one modulator valve on each side of an axle or axle group to control brake pressures independently, to improve braking performance on split-co road surfaces.
Six-Channel ABS	A system that has six sensors and six modulators (6S/6M).
Skid Number	A term representing the coefficient of friction (μ) of a given surface as a whole number by multiplying the coefficient of friction by 100: $0.70\mu \times 100 = 70$ Skid Number.
Software	As applied to ABSs, the complete package of programs consisting of the ABS algorithm, error checking diagnostics, engine management interface, and the structure which links everything together. Software, which is contained in the EPROM(s) inside the ECU, is a specific set of instructions that the ECU will execute to perform a particular task.
Solenoid	A device that converts an electrical signal into mechanical movement. It consists of a coil with a moveable core that changes positions by means of electromagnetism when current flows through the coil.
Split-Co	Split coefficient of friction. A condition in which one side of a vehicle is on a high coefficient of friction while the other side is on a low coefficient of friction (e.g., one side of the vehicle on dry pavement and one side on wet or icy pavement). This condition is most likely to cause the vehicle to experience yaw or a twisting/turning action during a stop without an operational ABS.
Spring Clip	See Sensor Bushing.
Static Fault	A fault detected with the wheel speed sensors or modulators when the wheels are not rotating. See Dynamic Fault.
Stop-Lamp Power	A design in which the ABS is powered only by the stop lamp circuit and requires no additional dedicated connector. See Full-Time Power.

Stopping Distance	The distance required to stop a vehicle. Stopping distance measurements begin when application (control) pressure first begins to increase, and end when the vehicle comes to a complete stop.
Tandem Control	An ABS design in which the four wheels of the tandem axle are controlled by only one modulator.
TMC	The Maintenance Council of the American Trucking Associations. An industry group which develops voluntary recommended practices on maintenance- and operation-related issues pertaining to commercial vehicles, based on input from equipment users, vehicle manufacturers, component suppliers, academia, and government representatives.
TMC RP 137	TMC Recommended Practice 137 is a voluntary standard that states tractors should deliver a minimum power level of 12.5 volts at 10 amps load to the trailer half of the tractor-to-trailer electrical connector.
TMC RP 141	TMC Recommended Practice 141 is a voluntary standard that states at least 9.5 volts (which includes a 1.0-volt safety margin) must be available at the trailer ABS ECU to ensure proper operation.
Tone Ring	See Exciter.
Traction Control	<p>A system to minimize drive wheel slip (improve traction) under acceleration. Traction control uses the ABS to apply braking pressure to a spinning wheel, transferring engine power to the wheel(s) with better traction. Should all the drive wheels start to slip, traction control system can improve vehicle traction by reducing engine torque. Traction control systems are referred to by several different names, depending on the manufacturer. These include:</p> <ul style="list-style-type: none">• Automatic Traction Control (ATC)• Traction Control (TC)• Automatic Slip Regulation or Anti-Spin Regulation (ASR)
Tooth Wheel	See Exciter.

Vehicle Power	The voltage and current delivered to various electrical and/or electronic devices on a vehicle. Typical vehicle power in North America is 9.0-16.0 volts direct current. European vehicles typically operate from 18.0-32.0 VDC. TMC Recommended Practice 137 establishes a voluntary standard that tractors should deliver a minimum power level of 12.5 volts at 10 amps load. TMC Recommended Practice 141 establishes a voluntary standard that at least 9.5 volts (which includes a 1.0-volt safety margin) must be available at the trailer ABS ECU to ensure proper operation.
Warning Lamp	See Malfunction Indicator Lamp
Wheel-by-Wheel Control	A type of ABS control in which each wheel is controlled individually.
Wheel Slip	The difference between vehicle speed and wheel speed, expressed as a percentage. The formula is: $\text{Wheel Slip} = \frac{(100)(\text{Vehicle Speed} - \text{Wheel Speed})}{\text{Vehicle Speed}}$.
Wheel Speed	The measured velocity of an individual (sensed) wheel which is derived by the ABS ECU. Wheel speed may differ from vehicle speed during wheel slip. See Wheel Slip.
Wheel Speed Sensor Pickup	A magnetic pickup-type sensor—coupled with an exciter or tooth wheel—that produces a signal to indicate wheel speed to the ECU. A permanent magnet and passing metal teeth combine to produce an electrical signal with a frequency proportional to the wheel speed. The teeth alter the magnetic field produced by the sensor. The changing magnetic field produces an AC voltage in pickup coil within the sensor.

VI. INDEX

Antilock Braking System (ABS)	3
adequate power	31-32
benefits	7
common problems	23
common sensor errors	26
common system errors	25
component descriptions	8-13
connector standardization	31
configuration	11-12, 33
defined	3-4
driving technique	6
fail-safe	7
features	7
faults	23
inspection	27-30
maintenance	27-30
mandate	3
operation	5
requirements for new vehicles	3-4
self-diagnostic capability	12
spec'ing considerations	31
troubleshooting	14-19
welding cautions related to ABS	22
Connectors	19, 31-32
ISO Connectors	31, 36
Seven-pin Connector (J560).....	31-32, 39
Diagnostics	12, 14-19, 22-23
general principles	14-18
tool compatibility	7
Disclaimer	2
Electrical/Electronic Connections	
service recommendations	19-22
Electronic Control Unit (ECU)	8
defined	8, 35
location	10
operation	8
Error Detection	23-25
Exciter	11
FMVSS 121	3, 36
Glossary of Terms	33

Grounding Recommendations 21

Inspection, ABS 27-30
 modulator valves 29

J560 31-32, 36

J1587 8,9, 36

J1708 37

J1922 8

J1939 8

Maintenance, ABS 27-30
 modulator valves 29-30
 sensor pickup adjustment 27
 sensor pickup removal and installation 27-29

Malfunction Indicator Lamp 7, 12, 23-24
 defined 12, 37
 diagnostic flowchart (typical) 24
 problems 23-24
 requirements 4, 12

Modulator Valves 10
 diagnostic flowchart (typical) 18
 inspection 29
 installation 30
 operation 10
 proper resistance 30
 removal 30

National Highway Traffic Safety Administration (NHTSA) 3-4, 37

Pickup See Sensor Pickup

RP 137 31-32

RP 141 31-32

Sensor Pickup 11, 27-29
 adjustment 27
 defined 11, 41
 exciter ring 11
 gap 26-27
 installation 27-29
 lubricant 28



Sensor Pickup (Continued)

operation 11
problems 25-26
removal 27-28
resistance 29

Seven-Pin Connector 31-32, 39

Spec'ing, ABS Considerations 31-32

Termination Techniques, Wiring 19-21

Tooth Wheel See Exciter

Traction Control 13

defined 13
operation 13

Warning Lamp See Malfunction Indicator Lamp

Welding, ABS-Related Cautions 22

Wheel Speed Sensors 11, See Sensor Pickup

Wiring Considerations..... 19-22

butt splices 21
grounding recommendations 21
repair damage 22
seven-pin connector 31-32
star washers, use of 22
termination techniques 19
wiring recommendations 32



Federal Highway Administration

400 Seventh Street, S.W.
Washington, D.C. 20590

Publication No. FHWA-MC-98-008
HCS-10/12-97(500)

